

# MPV OSTSEE

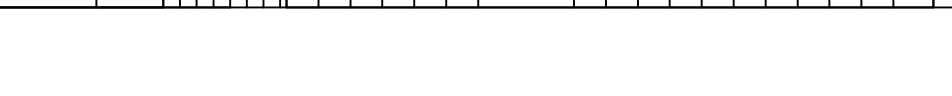
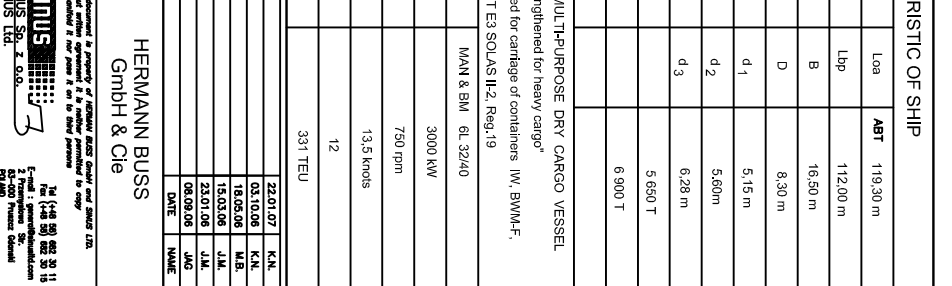
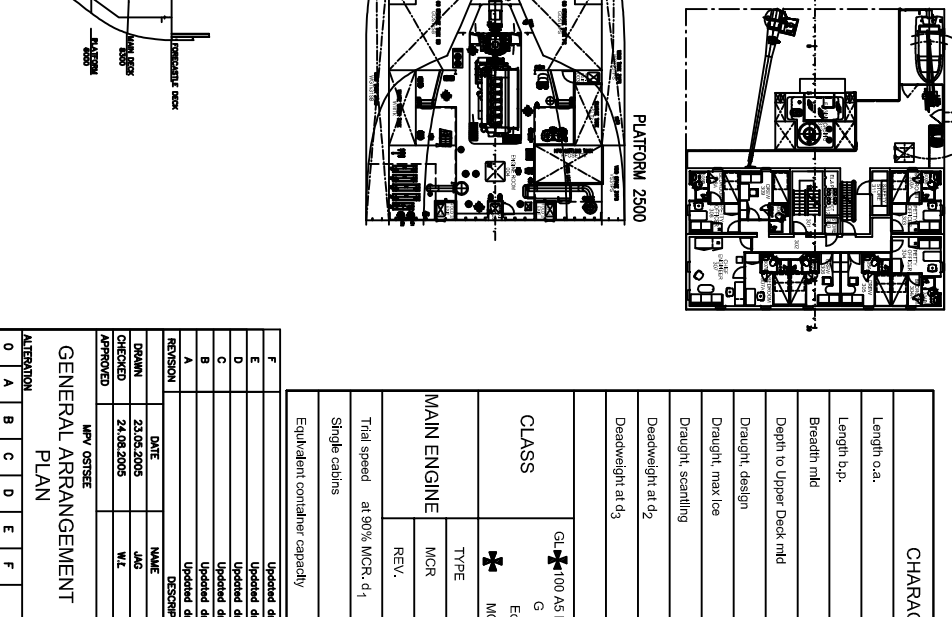
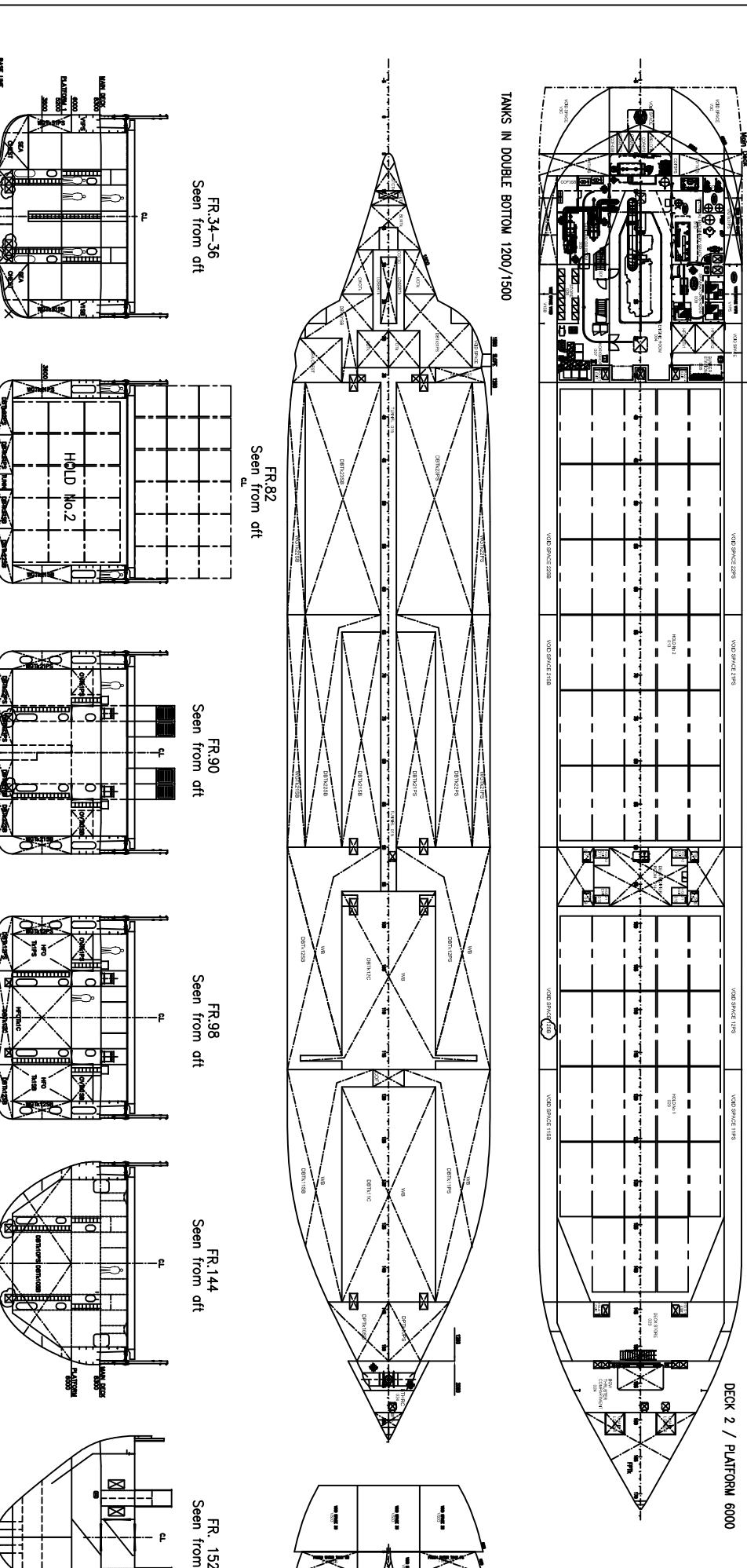
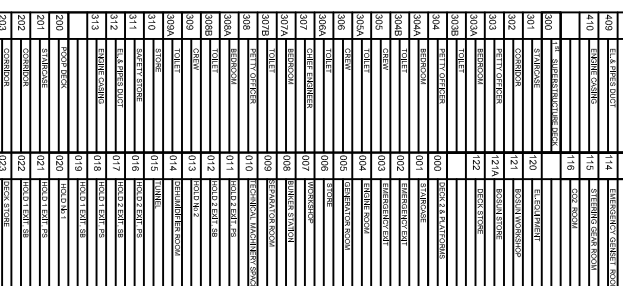
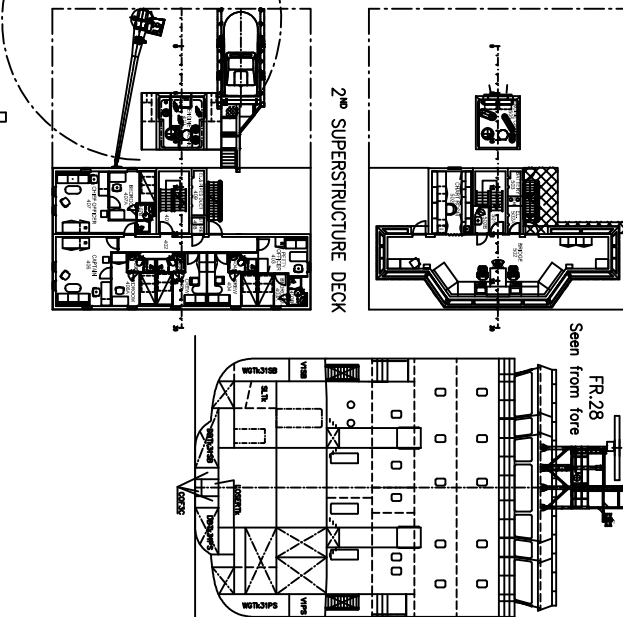
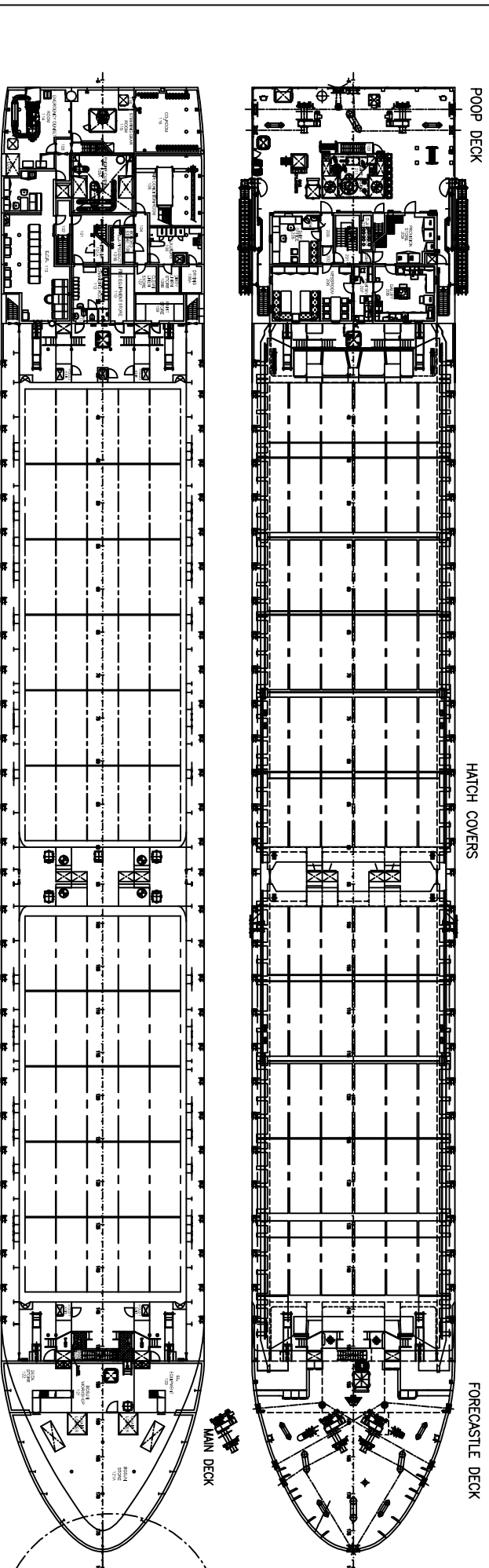
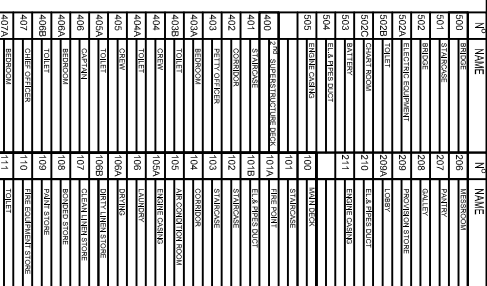
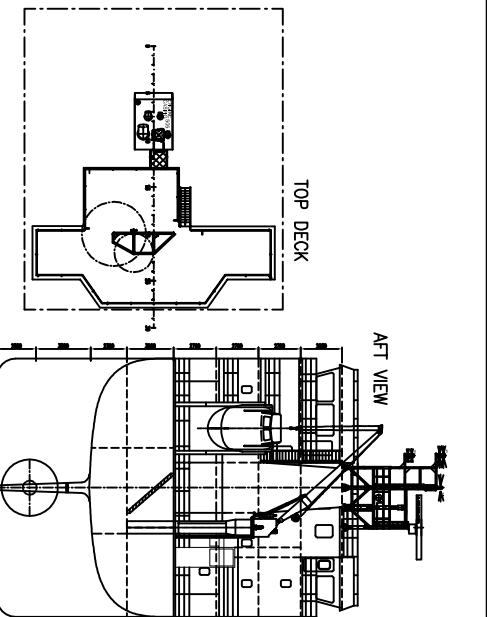
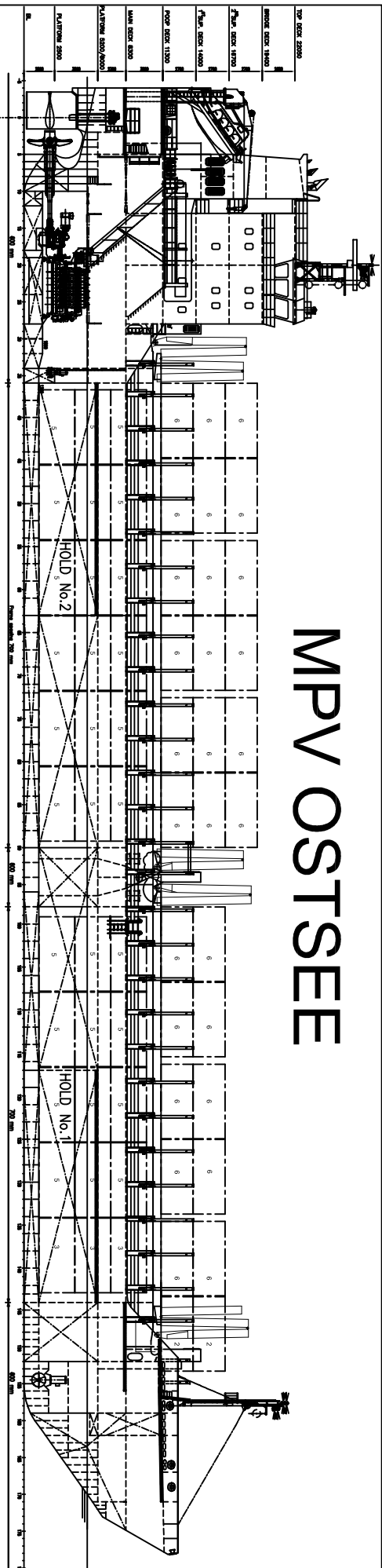

N°	NAME	N°	NAME
500	MAIN DECK	500	MAIN DECK
501	POOP DECK	501	POOP DECK
502	FORECASTLE DECK	502	FORECASTLE DECK
503	BRIDGE DECK	503	BRIDGE DECK
504	TOP DECK	504	TOP DECK
505	DECK 2 / PLATFORM 5200	505	DECK 2 / PLATFORM 5200
506	DECK 2 / PLATFORM 6000	506	DECK 2 / PLATFORM 6000
507	DECK 2 / PLATFORM 1200/1500	507	DECK 2 / PLATFORM 1200/1500
508	PLATFORM 2500	508	PLATFORM 2500
509	1 <sup>st</sup> SUPERSTRUCTURE DECK	509	1 <sup>st</sup> SUPERSTRUCTURE DECK
510	2 <sup>nd</sup> SUPERSTRUCTURE DECK	510	2 <sup>nd</sup> SUPERSTRUCTURE DECK
511	BRIDGE DECK	511	BRIDGE DECK
512	TOP DECK	512	TOP DECK
513	MAIN DECK	513	MAIN DECK
514	POOP DECK	514	POOP DECK
515	FORECASTLE DECK	515	FORECASTLE DECK
516	BRIDGE DECK	516	BRIDGE DECK
517	TOP DECK	517	TOP DECK
518	MAIN DECK	518	MAIN DECK
519	POOP DECK	519	POOP DECK
520	FORECASTLE DECK	520	FORECASTLE DECK
521	BRIDGE DECK	521	BRIDGE DECK
522	TOP DECK	522	TOP DECK
523	MAIN DECK	523	MAIN DECK
524	POOP DECK	524	POOP DECK
525	FORECASTLE DECK	525	FORECASTLE DECK

CHARACTERISTIC OF SHIP	
Length o.a.	Loa 119,30 m
Length b.p.	Lbp 112,00 m
Breadth mid	B 16,50 m
Depth to Upper Deck mid	D 8,30 m
Draught design	d.1 5,15 m
Draught max/ice	d.2 5,60m
Draught scantling	d.3 6,28 m
Deadweight at d2	5.660 T
Deadweight at d3	6.900 T

CLASS	
GL+100 AS E3 MULTI-PURPOSE DRY CARGO VESSEL	
G "Strengthened for heavy cargo"	
MC AUT E3 SOLAS II-2, Reg.19	

MAIN ENGINE	
TYPE	MAN 8 SM 6L 3240
MCR	3000 kW
REV.	750 rpm
Trial speed	at 90% MCR, d.1
Single cabins	13,5 knots
Equivalent container capacity	331 TEU

GENERAL ARRANGEMENT PLAN			
DATE	NAME	DATE	NAME
23.03.2005	JMG		
24.08.2005	W.E.		

REVISION		
NO.	DATE	DESCRIPTION
A	23.03.2005	Updated drawing
B	24.08.2005	Updated drawing
C	15.03.08	Updated drawing
D	23.01.08	Updated drawing
A	08.09.08	Updated drawing

DRAWN	
DATE	NAME
23.03.2005	JMG

CHECKED	
DATE	NAME
24.08.2005	W.E.

APPROVED	
DATE	NAME
23.03.2005	JMG

ATTENTION	
SCALE	SIZE
1:200	A3

GENERAL ARRANGEMENT PLAN	
DATE	NAME
23.03.2005	JMG

GENERAL ARRANGEMENT PLAN	
DATE	NAME
23.03.2005	JMG

HERMANN BUSS GmbH & Cie	
DATE	NAME
23.03.2005	JMG

SINUS	
DATE	NAME
23.03.2005	JMG

SINUS	
DATE	NAME
23.03.2005	JMG

SINUS	
DATE	NAME
23.03.2005	JMG

SINUS	
DATE	NAME
23.03.2005	JMG

SINUS	
DATE	NAME
23.03.2005	JMG

SINUS	
DATE	NAME
23.03.2005	JMG

SINUS	
DATE	NAME
23.03.2005	JMG

SINUS	
DATE	NAME
23.03.2005	JMG

SINUS	
DATE	NAME
23.03.2005	JMG

SINUS	
DATE	NAME
23.03.2005	JMG